

C-Series

CENTRIFUGAL PUMPS



Versatile Waukesha C-Series Centrifugal Pumps from Waukesha Cherry-Burrell find broad application throughout sanitary and industrial processes.

These rugged pumps accommodate a wide range of solids and liquids under a variety of flow conditions and deliver long service with minimum downtime.

SPX FLOW, Inc. (NYSE:FLOW) is a leading manufacturer of innovative flow technologies, many of which help define the industry standard in the market segments they serve. From its headquarters in Charlotte, North Carolina, it operates a sales and support network, centers of manufacturing excellence, and advanced engineering facilities, throughout the world. Its cutting-edge flow components and process equipment portfolio includes a wide range of pumps, valves, heat exchangers, mixers, homogenizers, separators, filters, UHT, and drying technology that meet many application needs. Its expert engineering capability also makes it a premium supplier of customized solutions and complete, turn-key packages to meet the most exacting of installation demands.

Incorporating many leading brands, SPX FLOW has a long history of serving the food and beverage, power and energy, and industrial market sectors. Its designs and engineered solutions help customers drive efficiency and productivity, increase quality and reliability, and meet the latest regulatory demands. In-depth understanding of applications and processes, state-of-the-art Innovation Centers, and advanced pilot/testing technology further assist in optimizing processes and reducing timescales to reliably meet production targets.

To learn more about SPX FLOW capabilities, its latest technology innovations and complete service offerings, please visit www.spxflow.com.

C-Series Centrifugal Pumps

FEATURES AND BENEFITS

- Long-life backplate and adapters - both backplate (with O-ring) and adapters are machined from solid bar stock stainless steel for optimum casing seal life and corrosion resistance.
- Long-life components — all “wet end” components are 316L stainless steel.
- 3A and CE certified

PRODUCT SPECIFICATIONS

Materials

Casing:

- 316L stainless steel

Backplate:

- 316L stainless steel

Impeller:

- 316L stainless steel

Port Connection:

- S-Line Standard
- I-Line Female
- Bevel Seat threaded or NPT (Male or Female) are optional

Seal Type:

- Type D Seal, external balanced (standard)
- Type F Seal (Type D with Cascade Seal Flush)
- Type DG Seal (clamped in seal/seat)
- Type E Seal (double mechanical)

Note: DG, F and E seal not available on C-100

Rotary Seal:

- Carbon (standard)
- Silicon Carbide & Tungsten Carbide (optional)
- DG Seal Seat Material: Silicon Carbide (standard)
- Siliconized Graphite, Ceramic & Tungsten Carbide (optional)

Elastomers:

- Buna (standard) or Fluoroelastemer (optional)

Finish:

- Sanitary Polish 32Ra (150 Grit)

Mounting:

- Pump head mounted to C-face motor; leg kit optional

Typical product applications



PRODUCT SPECIFICATIONS

Nominal Capacity:

- To 780 GPM (177 m³/hr)

Nominal Speed Range:

- 1450 or 2900 RPM–50HZ
- 1750 or 3500 RPM–60HZ

Temperatures: To 212°F (100°C)

Motor :

- Standard C-face; 3 phase, 230/460 volts; 1750 and 3500 RPM
- TEFC and Washdown Duty, Foot Mounted
- Other motor types upon request

MODEL NUMBER	INLET INCH (MM)	OUTLET INCH (MM)	MAXIMUM IMPELLER DIAMETER INCH (MM)	MAXIMUM CAPACITY		MAXIMUM HEAD	
				1750 RPM	3500 RPM	1750 RPM	3500 RPM
C-100	1.5 (38)	1 (25)	3.68 (93)	33 GPM (7m ³ /hr)	73 GPM (17m ³ /hr)	17 ft (5mm)	55 ft (17mm)
C-114	1.5 (38)	1.5 (38)	4.0 (101)	74 GPM (17m ³ /hr)	148 GPM (34m ³ /hr)	18 ft (5mm)	74 ft (23mm)
	2 (51)			84 GPM (19m ³ /hr)	180 GPM (41m ³ /hr)	17 ft (5mm)	69 ft (21mm)
C-216	2 (51)	1.5 (38)	6.0 (152)	145 GPM (33m ³ /hr)	280 GPM (64m ³ /hr)	42 ft (13mm)	169 ft (52mm)
	2.5 (63)			168 GPM (38m ³ /hr)	280 GPM (64m ³ /hr)	42 ft (13mm)	169 ft (52mm)
C-218	2 (51)	1.5 (38)	8.0 (203)	217 GPM (49m ³ /hr)	300 GPM (68m ³ /hr)	78 ft (23mm)	317 ft (97mm)
	3 (76)			230 GPM (52m ³ /hr)	305 GPM (69m ³ /hr)	76 ft (23mm)	305 ft (93mm)
C-328	3 (63)	2 (51)	8.0 (203)	416 GPM (94m ³ /hr)	635 GPM (144m ³ /hr)	74 ft (23mm)	304 ft (93mm)
	4 (101)			460 GPM (104m ³ /hr)	900 GPM (204m ³ /hr)	764 ft (23mm)	131 ft (95mm)

Bakery and Confectionery

- Batters
- Fats & Oils
- Flavorings
- Sweeteners
- Yeast Slurry
- Syrups



Dairy

- Whey
- Cream, Milk
- Sweetened Condensed
- RO/UF Systems



Pharmaceutical/Cosmetics

- Emulsions
- Extracts
- Slurries
- Syrups
- High Purity Water
- WFI (Water for Injection)
- Dyes, Alcohols
- Essential Oils



Chemical/Industrial

- Detergents
- Dyes
- Soap Liquors & Solutions
- Ammonium Nitrate
- Propyl Alcohol
- Potassium Chloride
- Sodium Acetate



Waukesha C-Series Sanitary Pumps

THEORY OF OPERATION



304 stainless steel adapters — standard, eliminate the rust, corrosion and chipping paint of conventional carbon steel adapters.



Fast, easy take down — no tools required; quick-opening, heavy-duty cast clamp secures casing; impeller pin retained by centrifugal force.



Longer seal life — wave spring provides more uniform loading on seal face than single coil spring; hydraulic balancing reduces sealing surface pressures for less wear and less downtime.



Tested performance — every pump passes strict testing before release for shipping.



CIP capability — grooves in impeller/shaft routes CIP chemical solutions to all critical areas for clean-in-place.



Casing matches job — choose from standard or enlarged inlet with port connection that meets your piping system.

PRODUCT DIMENSIONS

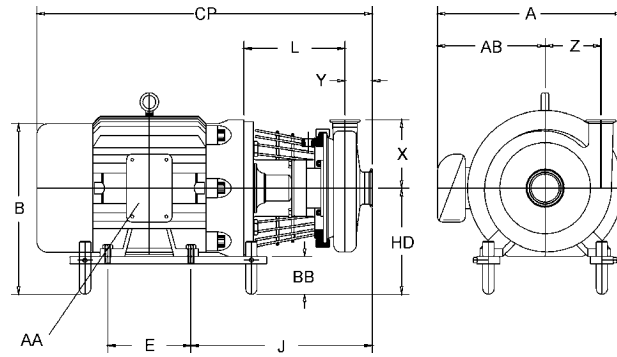

MODEL	FRAME	A IN (MM)	AA IN (MM)	AB IN (MM)	CP IN (MM)	D IN (MM)	E IN (MM)	J IN (MM)	L IN (MM)	O IN (MM)	X IN (MM)	Y IN (MM)	Z IN (MM)
C100	56C	7.34 (186)	.75 (19)	--	15.00 (381)	3.5 (89)	3.00 (76)	--	2.76 (70)	6.88 (175)	3.5 (89)	1.55 (39)	1.45 (37)
	143TC	7.41 (188)	.75 (19)	--	15.19 (386)	3.5 (89)	4.00 (102)	--	3.76 (96)	6.88 (175)	3.5 (89)	1.55 (39)	1.45 (37)
C114	56C	7.34 (186)	.75 (19)	--	18.64 (473)	3.50 (89)	3.00 (76)	10.38 (264)	6.22 (158)	6.88 (175)	3.63 (92)	1.59 (40)	2.63 (67)
	140TC	7.81 (198)	.75 (19)	--	19.08 (485)	3.50 (89)	5.00 (127)	10.69 (272)	6.22 (158)	6.88 (175)	3.63 (92)	1.59 (40)	2.63 (67)
	182TC	12.19 (310)	1.00 (25)	7.13 (181)	22.06 (560)	4.50 (114)	5.50 (140)	12.00 (305)	6.78 (172)	8.69 (221)	3.63 (92)	1.59 (40)	2.63 (67)
C216	56C	7.34 (186)	.88 (22)	--	17.00 (432)	3.50 (89)	3.00 (76)	10.53 (267)	6.06 (154)	6.88 (175)	4.50 (114)	1.91 (49)	3.69 (94)
	143TC	7.81 (198)	.88 (22)	--	18.44 (468)	3.50 (89)	4.00 (102)	10.84 (275)	6.06 (154)	6.88 (175)	4.50 (114)	1.91 (49)	3.69 (94)
	145TC	7.81 (198)	.88 (22)	--	19.25 (489)	3.50 (89)	5.00 (127)	10.84 (275)	6.06 (154)	6.88 (175)	4.50 (114)	1.91 (49)	3.69 (94)
	182TC	12.19 (310)	1.00 (25)	7.13 (181)	22.00 (559)	4.50 (114)	4.50 (114)	12.22 (310)	6.69 (170)	8.69 (221)	4.50 (114)	1.91 (49)	3.69 (94)
	184TC	12.19 (310)	1.00 (25)	7.13 (181)	22.31 (567)	4.50 (114)	5.50 (140)	12.22 (310)	6.69 (170)	8.69 (221)	4.50 (114)	1.91 (49)	3.69 (94)
	213TC	14.44 (367)	1.38 (35)	8.69 (221)	25.63 (651)	5.25 (133)	5.50 (140)	13.97 (355)	7.81 (198)	10.25 (260)	4.50 (114)	1.91 (49)	3.69 (94)
	215TC	14.44 (367)	1.38 (35)	8.69 (221)	26.19 (665)	5.25 (133)	5.50 (140)	13.97 (355)	7.81 (198)	10.25 (260)	4.50 (114)	1.91 (49)	3.69 (94)
	256TC	14.69 (373)	1.38 (35)	9.63 (245)	30.03 (763)	6.25 (159)	10.00 (254)	14.59 (371)	8.44 (214)	12.88 (327)	4.50 (114)	1.91 (49)	3.69 (94)
	145TC	7.81 (198)	.88 (22)	--	19.44 (494)	3.50 (89)	5.00 (127)	10.91 (277)	6.31 (160)	6.88 (175)	5.50 (140)	1.91 (49)	4.75 (121)
	182TC	12.19 (310)	1.00 (25)	7.13 (181)	21.94 (557)	4.50 (114)	4.50 (114)	12.28 (312)	6.94 (176)	8.69 (221)	5.50 (140)	1.91 (49)	4.75 (121)
184TC	12.19 (310)	1.00 (25)	7.13 (181)	22.50 (572)	4.50 (114)	5.50 (140)	12.28 (312)	6.94 (176)	8.69 (221)	5.50 (140)	1.91 (49)	4.75 (121)	
213TC	14.44 (367)	1.38 (35)	8.69 (221)	25.06 (637)	5.25 (133)	5.50 (140)	13.28 (337)	7.31 (186)	10.25 (260)	5.50 (140)	1.91 (49)	4.75 (121)	
215TC	14.44 (367)	1.38 (35)	8.69 (221)	25.88 (657)	5.25 (133)	7.00 (178)	13.28 (337)	7.31 (186)	10.25 (260)	5.50 (140)	1.91 (49)	4.75 (121)	
256TC	14.69 (373)	1.38 (35)	9.63 (245)	29.72 (755)	6.25 (159)	10.00 (254)	14.66 (372)	8.19 (208)	12.88 (327)	5.50 (140)	1.91 (49)	4.75 (121)	
284TSC	20.63 (524)	2.00 (51)	13.13 (334)	32.25 (819)	7.00 (178)	9.50 (241)	15.28 (388)	8.81 (224)	14.63 (372)	5.50 (140)	1.91 (49)	4.75 (121)	
286TSC	20.63 (524)	2.00 (51)	13.13 (334)	32.25 (819)	7.00 (178)	11.00 (279)	15.28 (388)	8.81 (224)	14.63 (372)	5.50 (140)	1.91 (49)	4.75 (121)	
182TC	12.19 (310)	1.00 (25)	7.13 (181)	22.63 (575)	4.50 (114)	4.50 (114)	13.09 (332)	7.25 (184)	8.69 (221)	5.50 (140)	2.22 (56)	4.75 (121)	
184TC	12.19 (310)	1.00 (25)	7.13 (181)	23.19 (589)	4.50 (114)	5.50 (140)	13.09 (332)	7.25 (184)	8.69 (221)	5.50 (140)	2.22 (56)	4.75 (121)	
213TC	14.44 (367)	1.38 (35)	8.69 (221)	25.75 (654)	5.25 (133)	5.50 (140)	14.09 (358)	7.63 (194)	10.25 (260)	5.50 (140)	2.22 (56)	4.75 (121)	
215TC	14.44 (367)	1.38 (35)	8.69 (221)	26.31 (668)	5.25 (133)	7.00 (178)	14.09 (358)	7.63 (194)	10.25 (260)	5.50 (140)	2.22 (56)	4.75 (121)	
256TC	14.69 (373)	1.38 (35)	9.63 (245)	30.41 (772)	6.25 (159)	10.00 (254)	15.47 (393)	8.50 (216)	12.88 (327)	5.50 (140)	2.22 (56)	4.75 (121)	
284TSC	20.63 (524)	2.00 (51)	13.13 (334)	32.94 (837)	7.00 (178)	9.50 (241)	16.09 (409)	9.13 (232)	14.63 (372)	5.50 (140)	2.22 (56)	4.75 (121)	
286TSC	20.63 (524)	2.00 (51)	13.13 (334)	32.94 (837)	7.00 (178)	11.00 (279)	16.09 (409)	9.13 (232)	14.63 (372)	5.50 (140)	2.22 (56)	4.75 (121)	
324TSC	23.13 (588)	2.00 (51)	14.13 (359)	35.44 (900)	8.00 (203)	10.50 (267)	17.16 (436)	9.69 (246)	16.50 (419)	5.50 (140)	2.22 (56)	4.75 (121)	
326TSC	23.13 (588)	2.00 (51)	14.13 (359)	35.44 (900)	8.00 (203)	12.00 (305)	17.16 (436)	9.69 (246)	16.50 (419)	5.50 (140)	2.22 (56)	4.75 (121)	

OPTIONS AND ACCESSORIES

Seal Options

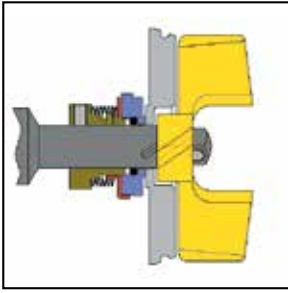

Type D
External Balanced Seal
This versatile, dependable seal finds broad use in sanitary and industrial applications. Seal material is carbon rotating on the stationary stainless steel.

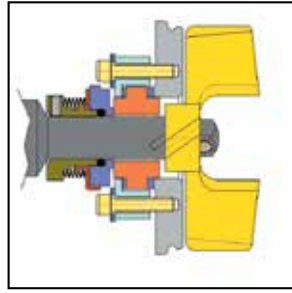

Type DG
Clamped-in Seal Seat
This seal is ideal for applications where resistance to corrosion is required or for abrasive or non-lubricating products. The DG utilizes Type D rotating seal components; however, the stationary seal seat material is silicon carbide, and is reversible for extended seat life.

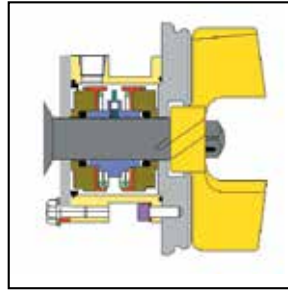

Type E
Double Mechanical Seal
This double mechanical seal can be pressurized with a flush media and discharged to drain. Ideal for vacuum, high temperature, abrasive or non-lubricating applications.

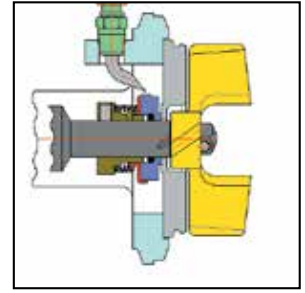

Type F
External Balanced, Water Cascade Seal
When Seal Type D applications include product temperatures that reach 212°F (100°C.) or vacuum over 14" Hg (355mm Hg), seal Type F is the choice. It includes the addition of a water cascading assembly that continually flushes the seal area.

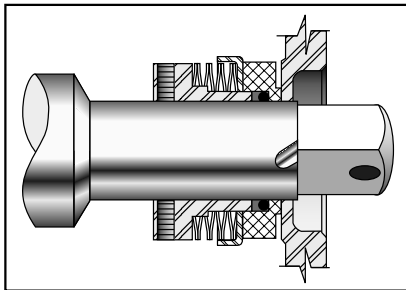

Wave spring extends seal life

- Wave spring maintains uniform loading on seal faces for longer seal service.

IEC International Version Available

- IEC Frame Adapter
- Hydraulic balancing reduces pressure at sealing surface for less wear
- Easy-cleaning, open type impeller delivers smooth pumping performance
- Enlarged inlets available for larger suction lines
- CIP capability standard
- 3A and CE certified
- Special European design shroud



ADDITIONAL TECHNICAL DATA

60 Hz

Pump Curves - 1750 RPM

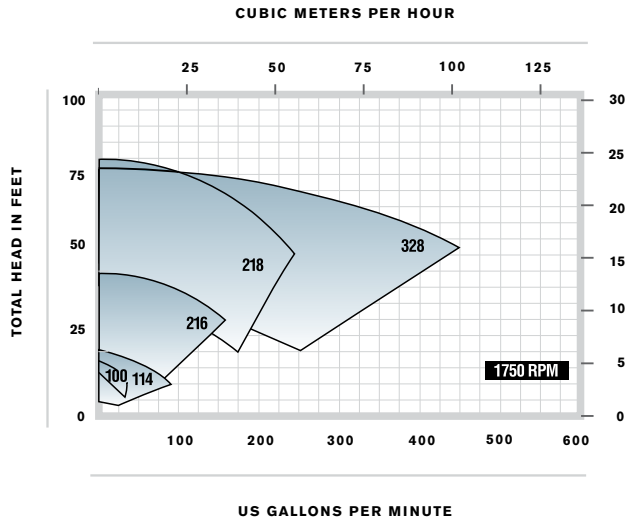

Pump Curves - 3500 RPM

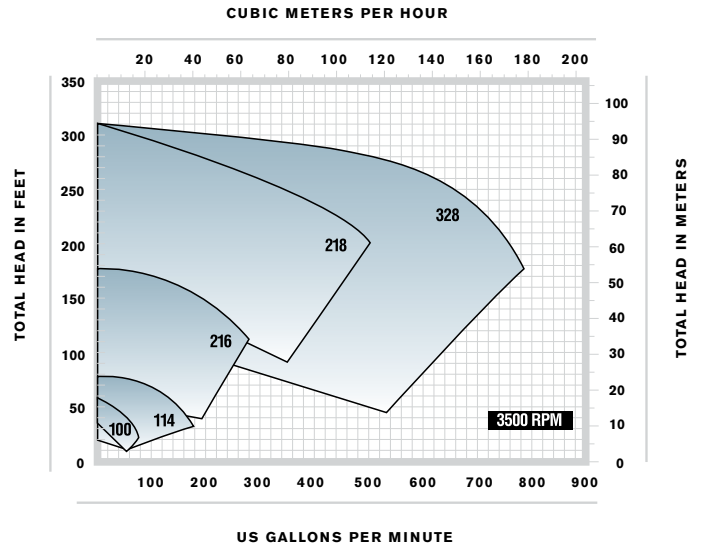

50 Hz

Pump Curves - 1450 RPM

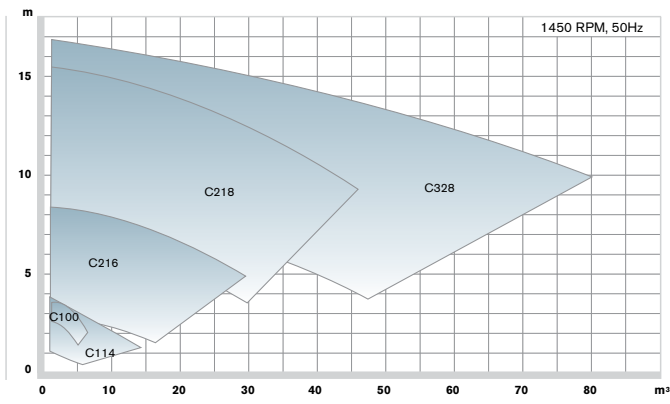

Pump Curves - 3500 RPM

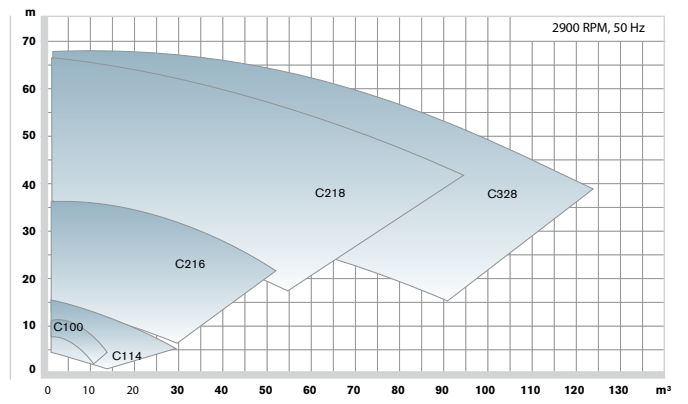

C-Series

CENTRIFUGAL PUMPS

SPX FLOW

SPX FLOW

611 Sugar Creek Road

Delavan, WI 53115

P: (262) 728-1900 or (800) 252-5200

F: (262) 728-4904 or (800) 252-5012

E: wcb@spxflow.com

SPX FLOW reserves the right to incorporate our latest design and material changes without notice or obligation.

Design features, materials of construction and dimensional data, as described in this bulletin, are provided for your information only and should not be relied upon unless confirmed in writing. Please contact your local sales representative for product availability in your region. For more information visit www.spxflow.com.

The green ">" is a trademark of SPX FLOW, Inc.

ISSUED 12/2015 FH-1735

COPYRIGHT © 2015 SPX FLOW, Inc.